

Line-up terminal

Features

ESC-CBC Series

- with UL94V-0 polyamide insulating body
- reduced overall dimension
- patented “Easy bridge” system: double possibility to insert PTC multi-pole cross-connections, without the need of insulating protection
- available in grey RAL 7042 and blue RAL 5015 colour version
- operating temperature range: $-40 \div +80 \text{ }^\circ\text{C}$

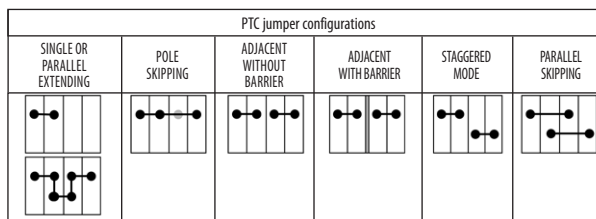

Terminal block	Jumper	Insulation voltage in the above configurations (V)					
ESC-CBC.2	ESC-PTC/2	630	630	1000	500	500	
ESC-CBC.4	ESC-PTC/4	630	500	800	500	500	
ESC-CBC.6	ESC-PTC/6	630	630	800	630	630	
ESC-CBC.10	ESC-PTC/10	800	630	800	800	630	
ESC-CBC.16	ESC-PTC/10	-	-	-	-	-	
ESC-CBC.35	ESC-PTC/10	-	-	-	-	-	

Technical data for ESC-CBC Series - grey and blue versions

	ESC-CBC.2(B)	ESC-CBC.4(B)	ESC-CBC.6(B)	ESC-CBC.10(B)	ESC-CBC.16(B)	ESC-CBC.35(B)	ESC-CBD.50(B)	ESC-CBD.70B	
TECHNICAL CHARACTERISTICS									
function / type	feed-through								
rated cross-section (mm ²)	2,5	4	6	10	25	50	50	70	
connecting capacity:									
flexible(mm ²)	0,2 ÷ 4	0,2 ÷ 6	0,2 ÷ 10	1,5 ÷ 16	1,5 ÷ 25	2,5 ÷ 50	1,5 ÷ 50	1,5 ÷ 95	
rigid(mm ²)	0,2 ÷ 4	0,2 ÷ 6	0,2 ÷ 10	1,5 ÷ 16	1,5 ÷ 25	2,5 ÷ 50	1 ÷ 70	1 ÷ 95	
max. flexible with ferrule (mm ²)-ferrule type	2,5 - WP25/14	4 - WP40/16	6 - WP60/20	10 - WP100/21	16 - WP160/22	35 - WP350/30	50 - WP500/40	-	
rated voltage / rated current / gauge conf. to IEC 60947-7-1	1000 V / 32 A (4 mm ²) / A3	1000 V / 41 A (6 mm ²) / A4	1000 V / 57 A (10 mm ²) / A5	1000 V / 76 A (16 mm ²) / B6	1000 V / 101 A (25 mm ²) / B7	1000 V / 150 A (50 mm ²) / B9	1000 V / 150 A	1000 V / 192 A	
rated voltage / rated current / AWG / tightening torque value UL	600 V / 20 A / 20-12 AWG / 0,4 Nm	600 V / 30 A / 20-10 AWG / 0,5 Nm	600 V / 50 A / 20-8 AWG / 1,7 Nm	600 V / 65 A / 14-6 AWG / 1,9 Nm	600 V / 100 A / 16-3 AWG / 2,8 Nm	600 V / 125 A / 20-1 AWG / 8,47 Nm	600 V / 130 A (*) / 16-1 AWG / 45 Nm	600 V / 220 A / 12 - 4/0 AWG / 68 Nm	
max current (*)	27 A (2,5 mm ²) / 37 A (4 mm ²)	38 A (4 mm ²) / 45 A (6 mm ²)	53 A (6 mm ²) / 64 A (10 mm ²)	70 A (10 mm ²) / 85 A (16 mm ²)	95 A (16 mm ²) / 114 A (25 mm ²)	134 A (35 mm ²) / 160 A (50 mm ²)			
rated impulse withstand voltage / pollution degree	12 KV / 3	12 KV / 3	12 KV / 3	12 KV / 3	12 KV / 3	12 KV / 3	12 KV / 3	12 KV / 3	
insulation stripping length (mm)	9	10	10	12	15	18	22	26	
tightening torque value (test / max) (Nm)	0,4 / 0,8	0,5 / 1,2	0,8 / 1,4	1,2 / 1,9	2 / 3	2,5 / 5	2,5 / 5	3 / 8	
height / width / thickness	TH/35 7,5 mm	52 / 44 / 5	52 / 44 / 6	52 / 44 / 8	52 / 44 / 10	56 / 47 / 12	63 / 56 / 16	62 / 57 / 18	71 / 62 / 20,5
height / width / thickness	TH/35 15 mm	60 / 44 / 5	60 / 44 / 6	60 / 44 / 8	60 / 44 / 10	64 / 47 / 12	71 / 56 / 16	70 / 57 / 18	79 / 62 / 20,5
Marking tag printed or blank	ES-NU0851	ES-NU0851	ES-NU0851	ES-NU0851	ES-NU0851	ES-NU0851	ES-NU0851	ES-NU0851	

Easy Bridge System

The cross-connection can be supplied in “standard” sizes, for 2-3-10 poles.

1 After having cut the bar according to the number of poles, insert the cross-connection, in the appropriate groove of the terminal block. At this point, by using the blade of a screwdriver, push down the cross-connection until it reaches its blocking point. The cross connection will be fully insulated and intrinsically IPXXB protected.

2 To remove the cross-connection: insert the blade of the screwdriver in the jumper slot, then lift it up and finally extract it.

Technical data

Cross connections Easy Bridge System

- screwless, snap-in insertion
- transversal and staggered mode connection possibility
- once inserted, intrinsically IPXXB protected resulting installation, without the need for further insulating covers
- patented system

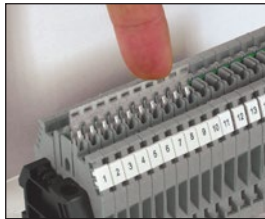

1

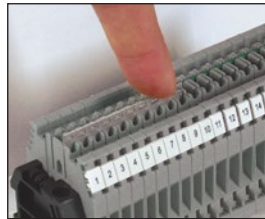

2

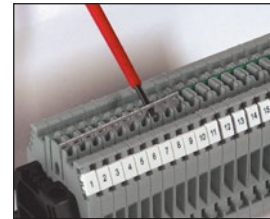

3

1-2 After having cut the bar according to the number of poles, insert the cross-connection, in the appropriate groove of the terminal block. At this point, by using the blade of a screwdriver, push down the cross-connection until it reaches its blocking point. The cross connection will be fully insulated and intrinsically IPXXB protected.

3 To remove the cross-connection, insert the blade of the screwdriver in the jumper slot, then lift it up and finally extract it.

Terminal block	2-pole jumper	10-pole jumper
ESC-CBC.2	ESC-PTC/2/02	ESC-PTC/2/10
ESC-CBC.4	ESC-PTC/4/02	ESC-PTC/4/10
ESC-CBC.6	ESC-PTC/6/02	ESC-PTC/6/10
ESC-CBC.10	ESC-PTC/10/02	ESC-PTC/10/10
ESC2-DBC.2(*)	ESC-PTC/2/02	ESC-PTC/2/10

Insulated cross connection

Nr. Poles	PTP Series - Blue	PTP Series - Red
2	ESC-PTP/2/02/B	ESC-PTP/2/02/R
3	ESC-PTP/2/03/B	ESC-PTP/2/03/R
10	ESC-PTP/2/10/B	ESC-PTP/2/10/R
2	ESC-PTP/4/02/B	ESC-PTP/4/02/R
3	ESC-PTP/4/03/B	ESC-PTP/4/03/R
10	ESC-PTP/4/10/B	ESC-PTP/4/10/R

ESC-POF permanent cross connections

Allowing the cross connection of two adjacent terminal blocks. Mounted in a suitable position in order to prevent injuries

Each ESC-POF jumper is composed by:

- 2 screws
- 2 sleeves
- 1 plate with 2 holes

All the components are in brass, with nickel plating.

Terminal block	Jumper type	Screw	Sleeve	Plate
		M x l [mm]	Ø x l [mm]	l x s [mm]
ESC-CBC.16	ESC-POF/53	M4 x 21	8 x 15	7 x 1,5
ESC-CBC.35	ESC-POF/35	M4 x 21	8 x 15	8 x 2

Terminal block	Screw/sleeve	Commoning bar	Commoning bar (Length, l x s)	Number of poles
ESC-CBC.16 / B	ESC-CPM/16	ESC-PMP/05	25 cm , 7 x 1,5	21
ESC-CBC.35 / B	ESC-CPM/35	ESC-PMP/35	25 cm , 10 x 4	16

ESC-PT end sections

For each type and cross section of terminal block, there is a specific insulating and closing end section to be placed on the open element of each terminal board. This end section may also be used to separate different phases of adjoining terminal blocks linked by cross connections or to increase insulation distances where specific circumstances may require it. The end sections have the same overall dimension as the related terminal block, thicknesses are given in the table below.

Terminal block	End section	
	Type	Thickness [mm]
ESC-CBC.2	ESC-CBC.2-10/PT	1,5
ESC-CBC.4	ESC-CBC.2-10/PT	1,5
ESC-CBC.6	ESC-CBC.2-10/PT	1,5
ESC-CBC.10	ESC-CBC.2-10/PT	1,5
ESC-CBC.16	ESC-CBC.16/PT	1,5
ESC-CBC.35	ESC-CBC.35/PT	1,5
ESC-CBD.50	ESC-CBD.50/PT	1
ESC-CBC.2B	ESC-CBC.2-10/PTB	1,5
ESC-CBC.4B	ESC-CBC.2-10/PTB	1,5
ESC-CBC.6B	ESC-CBC.2-10/PTB	1,5
ESC-CBC.10B	ESC-CBC.2-10/PTB	1,5
ESC-CBC.16B	ESC-CBC.16/PTB	1,5
ESC-CBC.35B	ESC-CBC.35/PTB	1,5
ESC-CBD.50B	ESC-CBD.50/PTB	1
ESC-CBD.70B	ESC-CBD.70/PTB	1
ESC2-DBC.2	ESC2-DBC.2/PT	1,5
ESC2-DBC.4	ESC2-DBC.4/PT	1,5
ESC-TLD, ESC-TDE	ESC-TLD/PT	1
ESC-TE0.2	ESC-TE0.2/PT	1,5
ESC-TE0.4	ESC-TE0.4/PT	1,5
ESC-SFR.4	ESC-SFR.4/PT	1,5
ESC-SFR.6	ESC-SFR.6/PT	1,5
ESC-CBS.2	ESC-MPS.4/PT	1,5

ESC-PRP protections

The cross connection, consisting of a multiple commoning bar and screws and sleeves, already placed in a recessed position with respect to the terminal board, can be further protected from accidental contact using a nylon U-shaped cover having a standard length of 10 cm. This white-coloured cover, can also be written upon, to serve as a label or reference point on the terminal board.

On the cover suitable slits are arranged to facilitate its removal by using a screwdriver.

for terminal blocks with a cross section of 4-16 mm ²	ESC-PRP/7
for terminal blocks with a cross section of 25-70 mm ²	ESC-PRP/8

ESC-DFU partitions

In polyamide available in red, colour, 1.5 mm thick, for the separation of elements on the terminal board, in order to make certain circuits easy to locate or to increase the insulation distances between terminal blocks.

The partitions can also be used to increase the insulation distances between adjacent parallel multiple commoning bars. White and green partitions available while stocks last.

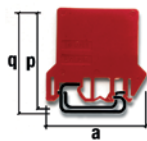

NOTE:
q dimension can be obtained by adding 4 mm to dimension p



Terminal block	Partition	Dimensions a x p
ESC-CBC.2	ESC-DFU/4	52 x 62
ESC-CBC.4	ESC-DFU/4	52 x 62
ESC-CBC.6	ESC-DFU/4	52 x 62
ESC-CBC.10	ESC-DFU/4	52 x 62
ESC-CBC.16	ESC-DFU/4	52 x 62
ESC-CBC.35	ESC-DFU/5	62 x 68
ESC2-DBC.2	ESC-DFU/7	80 x 64
ESC2-DBC.4	ESC-DFU/7	80 x 64
ESC-SCB.6 / DD / CD	ESC-DFU/6/R	72 x 74

ESC-DFM partition insulation of cross connections - bridges

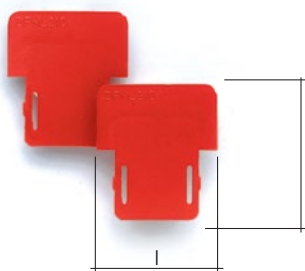
Red coloured in polyamide when it is necessary to guarantee the insulation distance between permanent or switchable cross connections, inserted between adjacent pairs of terminal blocks and, similarly, between multiple commoning bars, inserted between adjacent groups of terminal blocks.



Terminal block	Partition	Dimensions l x h [mm]	Thickness [mm]
ESC-CBC.2	ESC-DFM/900	17 x 18	0,5
ESC-CBC.4	ESC-DFM/900	17 x 18	0,5
ESC-CBC.6	ESC-DFM/900	17 x 18	0,5
ESC-CBC.10	ESC-DFM/900	17 x 18	0,5
ESC-CBC.16	ESC-DFM/700	28 x 32	0,5
ESC-CBC.35	ESC-DFM/700	28 x 32	0,5
ESC2-DBC.2	ESC-DFM/900	17 x 18	0,5
ESC2-DBC.4	ESC-DFM/900	17 x 18	0,5

Technical data for ESC-GPA & /FIX Series				
	ESC-GPA.70 & /FIX	ESC-GPA.95 & /FIX	ESC-GPA.150 & /FIX	ESC-GPA.240 & /FIX
TECHNICAL CHARACTERISTICS				
function / type	feed-through	feed-through	feed-through	feed-through
rated cross-section (mm ²)	70	95	150	240
connecting capacity:				
flexible (mm ²)	10 ÷ 95	10 ÷ 95	50 ÷ 150	95 ÷ 240
rigid (mm ²)	10 ÷ 95	10 ÷ 120	50 ÷ 185	50 ÷ 300
bars and/or cable lugs	-	-	-	-
rated voltage / rated current / gauge conf. to IEC 60947-7-1	1000 V / 192 A / B11	1000 V / 232 A / B12	1000 V / 309 A / B14	1000 V / 415 A / B16
rated voltage / rated current / AWG / tightening torque value UL	1000 V / 215 A / 8 AWG str. ÷ 4/0 AWG str. / 79,5 lb.in	1000 V / 232 A / 2 AWG sol./str. ÷ 250 MCM str. / 90 lb.in.	1000 V / 309 A / 1/0 AWG str ÷ 350 MCM str. / 142 lb.in	1000 V / 415 A / 3/0 AWG str. ÷ 600 MCM str. / 300 lb.in.
rated impulse withstand voltage / pollution degree	12 KV / 3	12 KV / 3	12 KV / 3	12 KV / 3
insulation stripping length (mm)	25	30	35	40
tightening torque value - bar (test / recommended) (Nm)	-	-	-	-
tightening torque value - cable (test / recommended) (Nm)	6 / 9 (Allen screw, 4 mm wrench)	6 / 9 (Allen screw, 4 mm wrench)	10 / 15 (Allen screw, 5 mm wrench)	14 / 21 (Allen screw, 6 mm wrench)
height / width / thickness  TH/35 7,5 mm	70 / 91 / 20,5	87 / 98 / 26	99 / 108 / 31	120 / 119 / 37
height / width / thickness  TH/35 15 mm	78 / 91 / 20,5	95 / 98 / 26	106 / 108 / 31	128 / 119 / 37
height / width / thickness  G32	75 / 91 / 20,5	91 / 98 / 26	103 / 108 / 31	124 / 119 / 37
height / width (fixing distance between centres) / thickness (panel mount)	75 / 102 (88) / 20,5	91 / 111 (97) / 26	94 / 122 (106) / 31	115 / 134 (118) / 37
Marking tag printed or blank	ES-NU0851	ES-NU0851	ES-NU0851	ES-NU0851
End bracket	ES-BTO, ES-BT/3	ES-BTO, ES-BT/3	ES-BTO, ES-BT/3	ES-BTO, ES-BT/3

ESC-GPM.FIX Series high current terminal block

- conductor: cable or bar
- nominal voltage 1000 V
- panel mount version - M6 screws (recommended with screwdriver and washer slot)
- available in grey
- operating temperature range: -40 ÷ +80 °C
- maximum continual operating temperature 100 °C
- extra protection for bars

Technical data for ESC-GPM.FIX Series - Panel-mount version			
	ESC-GPM.95 & /FIX	ESC-GPM.150 & /FIX	ESC-GPM.240 & /FIX
TECHNICAL CHARACTERISTICS			
function / type	feed-through	feed-through	feed-through
rated cross-section (mm ²)	95/150	150/240	240/300
bars and/or cable lugs	22 mm maximum width (M8 bolt) (*)	32 mm maximum width (M10 bolt) (**)	40 mm maximum width (M12 bolt) (***)
rated voltage / rated current / gauge conf. to IEC 60947-7-1	1000 V / 232 A	1000 V / 309 A	1000 V / 415 A
max. current	320A	440A	600A
rated impulse withstand voltage / pollution degree	12 KV / 3	12 KV / 3	12 KV / 3
tightening torque value - bar (test / recommended) (Nm)	6 / 9 (13 mm wrench)	10 / 15 (key 17 mm)	14 / 21 (key 19 mm)
height / width (fixing distance between centres) / thickness (panel mount)	76 / 176 (158) / 32	76 / 200 (158) / 42	84 / 250 (172) / 52
Marking tag printed or blank	ES-NU0851	ES-NU0851	ES-NU0851
End bracket	ES-BTO, ES-BT/3	ES-BTO, ES-BT/3	ES-BTO, ES-BT/3

(*) distance between the cable lug fixing screw axis and the conducting body: 10 mm

(**) distance between the cable lug fixing screw axis and the conducting body: 12 mm

(***) distance between the cable lug fixing screw axis and the conducting body: 15 mm

Technical data

Features

Earth terminal blocks ESC-TEO

- with UL94V-0 polyamide insulating body
- mounting onto rails - according to IEC 60715 Std., "G32" and "TH/35" types
- in a single green / yellow insulating case

Technical data for ESC-TEO Series - version for DIN rail mounting		ESC-TEO.2	ESC-TEO.4
TECHNICAL CHARACTERISTICS			
function / type		earth	earth
rated cross-section (mm ²)		2,5	4
connecting capacity:			
flexible(mm ²)		0,2 ÷ 4	0,2 ÷ 6
rigid(mm ²)		0,2 ÷ 4	0,2 ÷ 6
max. flexible with ferrule (mm ²)-ferrule type		2,5 - WP25/14	4 - WP40/16
rated voltage / rated current / gauge conf. to IEC 60947-7-1		- / - / A3	- / - / A4
rated voltage / rated current / AWG / tightening torque UL		- / - / 20-14 AWG / 5,5 lb.in.	- / - / 20 ÷ 12 AWG / 5,5 lb.in.
rated impulse withstand voltage / pollution degree		8 KV / 3	8 KV / 3
insulation stripping length (mm)		12	14
tightening torque value (test / max) (Nm)		0,4 / 0,8	0,5 / 1,2
height / width / thickness	TH/35 7,5 mm	47 / 50 / 5,5	52 / 50 / 6,5
height / width / thickness	TH/35 15 mm	55 / 50 / 5,5	60 / 50 / 6,5
height / width / thickness	G32	-	-
Marking tag	printed or blank	ES-NU0851	ES-NU0851



MAXIMUM SHORT-TIME WITHSTAND CURRENTS ALLOCATED TO THE RAIL PROFILE				
Rail profile	Material	Equivalent E-cu cross-section mm ²	Short-time withstand current 1 s kA	Thermal rated current of a PEN busbar A
"Top hat" rail IEC 60715/TH 15 - 5,5	Steel	10	1,2	-
	Copper	25	3	101
	Aluminium	16	1,92	76
G32-type rail IEC 60715/G32	Steel	35	4,2	-
	Copper	120	14,4	269
	Aluminium	70	8,4	192
"Top hat" rail IEC 60715/TH 35 - 7,5	Steel	16	1,92	-
	Copper	50	6	150
	Aluminium	35	4,2	125
"Top hat" rail IEC 60715/TH 35 - 15	Steel	50	6	-
	Copper	150	18	309
	Aluminium	95	11,4	232

Taken from CEI EN 60947-7-2 standard

Features

Earth terminal blocks ESC-TEC

- with UL94V-0 polyamide insulating body
- mounting onto rails - according to IEC 60715 Std., "G32" and "TH/35" types
- in 2 green / yellow insulating cases
- same profile and dimensions of the corresponding terminals of the ESC-CBC and ESC-GPA Series

Technical data for ESC-TEC Series - version for DIN rail mounting					
	ESC-TEC.6/0	ESC-TEC.10/0	ESC-TEC.16/0	ESC-TEC.35/0	ESC-TEC.70/0
TECHNICAL CHARACTERISTICS					
function / type	earth terminal block	earth terminal block	earth terminal block	earth terminal block	earth terminal block
rated cross-section (mm ²)	6	10	16	35	71
connecting capacity:					
flexible(mm ²)	0,5 ÷ 10	1,5 ÷ 16	1,5 ÷ 25	2,5 ÷ 50	10 ÷ 95
rigid(mm ²)	0,5 ÷ 10	1,5 ÷ 16	1,5 ÷ 25	2,5 ÷ 50	10 ÷ 95
max. flexible with ferrule (mm ²)-ferrule type	6 - WP60/20	10 - WP100/21	16 - WP160/22	-	-
rated voltage / rated current / gauge conf. to IEC 60947-7-1	- / 41 A / A5	- / 57 A / B6	- / 76 A / B7	- / 125 A / B9	- / 192 A / B11
rated voltage / rated current / AWG UL	-	-	-	-	-
max current (*)	-	-	-	-	-
rated impulse withstand voltage / pollution degree	12 KV / 3	12 KV / 3	12 KV / 3	12 KV / 3	12 KV / 3
insulation stripping length (mm)	10	12	18	18	25
tightening torque value (test / max) (Nm)	0,8 / 1,4	1,2 / 1,9	-	2,5 / 5	6 / 9
height / width / thickness  TH/35 7,5 mm	52 / 44 / 8	52 / 44 / 10	56 / 47 / 12	63 / 56 / 16	74 / 70 / 20,5
height / width / thickness  TH/35 15 mm	60 / 44 / 8	60 / 44 / 10	64 / 47 / 12	71 / 56 / 16	81,5 / 70 / 20,5
height / width / thickness  G32	53 / 44 / 8	53 / 44 / 10	57 / 47 / 12	64 / 56 / 16	75 / 70 / 20,5
Marking tag	printed or blank	ES-NU0851	ES-NU0851	ES-NU0851	ES-NU0851

MAXIMUM SHORT-TIME WITHSTAND CURRENTS ALLOCATED TO THE RAIL PROFILE				
Rail profile	Material	Equivalent E-cu cross-section mm ²	Short-time withstand current 1 s kA	Thermal rated current of a PEN busbar A
"Top hat" rail IEC 60715/TH 15 - 5,5	Steel	10	1,2	-
	Copper	25	3	101
	Aluminium	16	1,92	76
G32-type rail IEC 60715/G32	Steel	35	4,2	-
	Copper	120	14,4	269
	Aluminium	70	8,4	192
"Top hat" rail IEC 60715/TH 35 - 7,5	Steel	16	1,92	-
	Copper	50	6	150
	Aluminium	35	4,2	125
"Top hat" rail IEC 60715/TH 35 - 15	Steel	50	6	-
	Copper	150	18	309
	Aluminium	95	11,4	232

Taken from CEI EN 60947-7-2 standard

Technical data

Features

ESC2-DBC Series - on two & three levels

- with UL94V-0 polyamide insulating body
- feed-through
- feed-through, equipped with internal cross-connection
- available in standard grey RAL 7042
- to be mounted according to IEC 60715 Std., "TH/35" type
- ESC2-DBC.4: Four slots meant for insert permanent cross-connection "Easy Bridge"

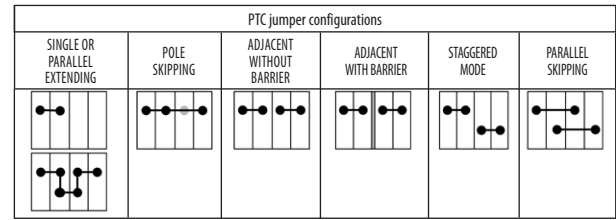

Insulation voltage in the above configurations (V)					
630	500		250 (*) 630 (**)	500	500

Technical data for ESC2-DBC Series

	ESC2-DBC.2	ESC2-DBC.4
TECHNICAL CHARACTERISTICS		
function / type	2 level feed-through	2 level feed - through
rated cross-section (mm ²)	2,5	4
connecting capacity:		
flexible(mm ²)	0,2 ÷ 4	0,2 ÷ 6
rigid(mm ²)	0,2 ÷ 4	0,2 ÷ 6
max. flexible with ferrule (mm ²)-ferrule type	2,5 - WP25/14	4 - WP40/16
rated voltage / rated current / gauge conf. to IEC 60947-7-1	630 V / 24 A / A3	630 V / 32 A / A4
rated voltage / rated current / AWG / tightening torque value UL	600 V / 20 A / 28-12 AWG / 8 lb.in	-
max current (***)	27 A (2,5 mm ²) / 34 A (4 mm ²)	-
rated impulse withstand voltage / pollution degree	8 KV / 3	8 KV / 3
insulation stripping length (mm)	9	9
tightening torque value (test / max) (Nm)	0,4 / 0,8	0,5 / 1
height / width / thickness	66 / 70 / 5	66 / 70 / 6
height / width / thickness	74 / 70 / 5	74 / 70 / 6
Marking tag printed or blank	ES-NU0851	ES-NU0851

(*)between lower levels (with partition)

(**)between upper levels (with partition)

(***)value referred to the characteristics of the terminal block alone, within the temperature range according to IEC 60947-7-1 Std.

Technical data for ESC2-DBC Series

	ESC-TLD.2(B)	ESC-TDE.2
TECHNICAL CHARACTERISTICS		
function / type	3 feed-through levels	2 feed-through levels + earth
rated cross-section (mm ²)	2,5	2,5
connecting capacity:		
flexible(mm ²)	0.2 ÷ 4	0.2 ÷ 4
rigid(mm ²)	0.2 ÷ 4	0.2 ÷ 4
max. flexible with ferrule (mm ²)-ferrule type	2,5	2,5
rated voltage / rated current / gauge conf. to IEC 60947-7-1	250 V / 24 A	250 V / 24 A
rated voltage / rated current / AWG / tightening torque value UL	600 V / 15 A (*) / 20 - 12 AWG / 3.5 lb.in	600 V / 20 A (*) / 20 - 12 AWG / 3.5 lb.in
rated impulse withstand voltage / pollution degree	4 KV / 3	4 KV / 3
insulation stripping length (mm)	8	8
tightening torque value (test / max) (Nm)	0.4 / 0.8	0.4 / 0.8
height / width / thickness	52 / 85 / 6.2	52 / 85 / 6.2
height / width / thickness	60 / 85 / 6.2	60 / 85 / 6.2
Marking tag printed or blank	ES-NU0851	ES-NU0851

(*)between lower levels (with partition)

(**)between upper levels (with partition)



Features

ESC-SFR Series - Fuse-holders

- with UL94V-0 polyamide insulating body
- available in grey RAL 7042 colour
- universal mounting onto rails - according to IEC 60715 Std., "G32" and "TH/35" types
- ESC-SFR.4: for $\varnothing 5 \times 20$ mm fuses, with possibility to detect the fuse blow-out status, by means of a LED micro-circuit (CIL...)
- ESC-SFR.6: for $\varnothing 6.3 \times 32$ mm fuses, with solder lug

Max. dissipated power – In conf. with IEC 60947-7-3				
Terminal block	Voltage [V] (*)	Current [A]	Protection against overload and short circuit	Only protection against short circuit
			(PV) - [W]	(PV) - [W]
ESC-SFR.4	250	6,3	2,5	2,5
ESC-SFR.6	250	10	2,5	4

Technical data for ESC-SFR Series

	ESC-SFR.4	ESC-SFR.6
TECHNICAL CHARACTERISTICS		
function / type	for $\varnothing 5 \times 20$ mm fuses	for $\varnothing 6,3 \times 32$ mm fuses
rated cross-section (mm ²)	4	6
connecting capacity:		
flexible(mm ²)	0,2 ÷ 6	0,2 ÷ 10
rigid(mm ²)	0,2 ÷ 6	0,2 ÷ 10
max. flexible with ferrule (mm ²)-ferrule type	4 - WP40/16	6 - WP60/20
rated voltage / rated current / gauge conf. to IEC 60947-7-1	800 V (*) / 6,3 A max (20 A with CO/5) / A4	630 V (*) / 10 A / A5
rated voltage / rated current / AWG / tightening torque value UL	600 V / 6,3 A / 20-12 AWG / 4,4 lb.in.	600 V / 10 A / 20-8 AWG / 13 lb.in
rated impulse withstand voltage / pollution degree	6 KV / 3	6 KV (*) / 3
insulation stripping length (mm)	11	11
tightening torque value (test / max) (Nm)	0,5 / 1,2	0,8 / 1,4
height / width / thickness	 TH/35 7,5 mm	52 / 52 / 8
height / width / thickness	 TH/35 15 mm	60 / 52 / 8
height / width / thickness	 G32	56 / 52 / 8
Marking tag	printed or blank	ES-NU0851

(*) value referred to the insulation characteristics of the terminal block

Conducting elements

ESC-CO/5

$\varnothing 5 \times 20$ mm



Technical data

Features

ESC-CBS.2 - DISCONNECT

- with UL94V-0 polyamide insulating body
- Disconnect lever
- Possibility to perform cross-connections
- “Easy Bridge” system: multi-pole cross-connection without the need of additional protection
- Cross connections lined up with feed-through and fuse holders for a faster realisation of complicated circuits

Technical data for ESC-CBS Series



		ESC-CBS.2
TECHNICAL CHARACTERISTICS		
function / type		Disconnect lever
rated cross-section	(mm ²)	2
connecting capacity:		
flexible(mm ²)		0,2 ÷ 4
rigid(mm ²)		0,2 ÷ 4
max. flexible with ferrule (mm ²)-ferrule type		2,5 - WP25/14
rated voltage / rated current / gauge conf. to IEC 60947-7-1		630 V / 22 A / A3
rated voltage / rated current / AWG / tightening torque value UL		-
rated impulse withstand voltage / pollution degree		6 KV / 3
insulation stripping length	(mm)	9
tightening torque value (test / max)	(Nm)	0,4 / 0,6
height / width / thickness	TH/35 7,5 mm	52 / 57 / 5
height / width / thickness	TH/35 15 mm	60 / 57 / 5
ACCESSORIES		
End sections	grey	ESC-MPS.4/PT
Permanent cross connection (intrinsically IPXXB protected once mounted)		ESC-PTC/2/02
		ESC-PTC/2/10
Cross connection barrier	red	ESC-DFM/900
Marking tag	printed or blank	ES-NU0851

Disconnect terminal blocks for test and measurement circuits ESC-SCB series

Technical data for ESC-SCB series

		ESC-SCB.4	ESC-SCB.6	SCB.6/DD	ESC-SCB.6/CD
TECHNICAL CHARACTERISTICS					
function / type		disconnect by slide link	disconnect by slide link	disconnect by slide link in special configuration for voltmetric circuits	disconnect by slide link in special configuration for amperometric circuits
rated cross-section	(mm ²)	4	6	6	6
connecting capacity:					
flexible	(mm ²)	0,2-6	0,5-10	0,5-10	0,5-10
rigid	(mm ²)	0,2-6	0,5-10	0,5-10	0,5-10
max. flexible with ferrule	(mm ²)	4	6	6	6
rated voltage / rated current / gauge conf. to IEC 60947-7-1		800 V / 32 A / A4	800 V / 41 A / A5	800 V / 41 A / A5	800 V / 41 A / A5
rated voltage / rated current / AWG / tightening torque value UL		600 V / 20 A / 20-12 AWG / 4.4 lb.in.	600 V / 47 A / 20-8 AWG / 13.3 lb.in.	-	-
rated impulse withstand voltage / pollution degree		8 KV / 3	8 KV / 3	8 KV / 3	8 KV / 3
insulation stripping length	(mm)	9	12	12	12
tightening torque value (test / recommended)	(Nm)	0.5 / 1.2	0.8 / 1.4	0.8 / 1.4	0.8 / 1.4
height / width / thickness	TH/35 7,5 mm	44 / 58 / 6.5	65 / 69 / 8	76 / 69 / 8	77 / 69 / 8
height / width / thickness	TH/35 15 mm	52 / 58 / 6.5	73 / 69 / 8	84 / 69 / 8	85 / 69 / 8
height / width / thickness	G32	48 / 58 / 6.5	68 / 69 / 8	79 / 69 / 8	80 / 69 / 8
ACCESSORIES					
End section		ESC-SCB.4/PT	ESC-SCB.6/PT	ESC-SCB.6/PT	ESC-SCB.6/PT
Coloured partition		-	ESC-DFU/6/R	ESC-DFU/6/R	ESC-DFU/6/R
Test plug socket		ESC-PSD/A	ESC-PSD/P	2 pcs. Included	2 pcs. Included
Short-circuit plate between - 2 adjoining terminal blocks		-	ESC-SCB.6/PO-2	ESC-SCB.6/PO-2	ESC-SCB.6/PO-2
Short-circuit plate between - 4 adjoining terminal blocks		-	ESC-SCB.6/PO-4	ESC-SCB.6/PO-4	ESC-SCB.6/PO-4
Marking tag	printed or blank	ES-NU0851	ES-NU0851	ES-NU0851	ES-NU0851
End bracket		ES-BTO, ES-BT/3	ES-BTO, ES-BT/3	ES-BTO, ES-BT/3	ES-BTO, ES-BT/3

Technical data for ESC-QBLOK Series

	ESC-QBLOK7001	ESC-QBLOK7002	ESC-QBLOK1201	ESC-QBLOK1202
TECHNICAL CHARACTERISTICS				
function / type	Distribution rail assembly			
rated cross-section (mm ²)	10			
connecting capacity:				
flexible(mm ²)	1,5 ÷ 10			
rigid(mm ²)	1,5 ÷ 16			
max. flexible with ferrule (mm ²)-ferrule type	10 - WP100/21			
rated voltage / rated current / gauge conf. to IEC 60947-7-1	500 V / 63 A / B5			
rated impulse withstand voltage / pollution degree	-			
insulation stripping length (mm)	6			
tightening torque value (test / max) (Nm)	2 / 2,5			
height / width / thickness 	33 - 53 - 16		33 - 85 - 16	
height / width / thickness 	41 - 53 - 16		41 - 85 - 16	
Color	blue	green	blue	green

Features

ESC-QBLOK

- with UL94V-0 polyamide insulating body
- available in 7 and 12 hole versions
- mounted onto PR/3 profiles conforming to IEC 60715 standards, TH/35 type
- inherent protection against accidental contact IPXXB level according to IEC 60529
- possible to label with a CNU/8 tag
- conformance to EN 60998-1:2004 and EN 60998-2-1:2004 regulations

Features

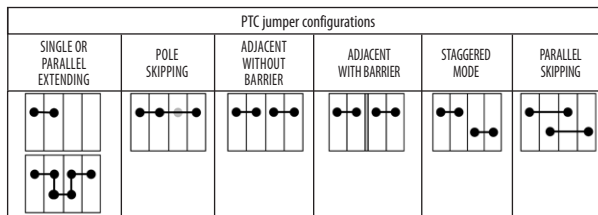

ESP-HMM Series

- with UL94V-0 polyamide insulating body
- mounting onto rails according to IEC 60715 Std., "TH/35" type
- available in standard grey RAL 7042 colour and blue RAL 5015 colour version



Terminal block	Jumper	Insulation voltage in the above configurations (V)					
ESP-HMM.1	-	630	630	320	630	630	
ESP-HMM.2	-	630	630	320	630	630	
ESP-HMM.4	ESC-PTC/5	500	500	500	500	500	
ESP-HMM.6	ESC-PTC/8	500	500	500	500	500	
ESP-HMM.10	ESC-PTC/11	1000	1000	800	1000	800	
ESP-HMM.16	ESC-PTC/16	1000	1000	800	1000	800	

Technical data for ESP-HMM Series - grey and blue

	ESP-HMM.1(B)	ESP-HMM.2(B)	ESP-HMM.4(B)	ESP-HMM.6(B)	ESP-HMM.10(B)	ESP-HMM.16(B)
TECHNICAL CHARACTERISTICS						
function / type	feed-through	feed-through	feed-through	feed-through	feed-through	feed-through
rated cross-section (mm ²)	1,5	2,5	4	6	10	16
connecting capacity:						
flexible(mm ²)	0,2 ÷ 2,5	0,2 ÷ 4	0,2 ÷ 6	0,2 ÷ 10	1,5 ÷ 16	1,5 ÷ 25
rigid(mm ²)	0,2 ÷ 2,5	0,2 ÷ 4	0,2 ÷ 6	0,2 ÷ 10	1,5 ÷ 16	1,5 ÷ 25
max. flexible with ferrule (mm ²)-ferrule type	1,5 - WP15/14	2,5 - WP25/14	4 - WP40/16	6 - WP60/20	10 - WP100/21	16 - WP160/22
rated voltage / rated current / gauge conf. to IEC 60947-7-1	500 V / 17,5 A / B2	800 V / 24 A / A3	800 V / 32 A / A4	800 V / 41 A / A5	1000 V / 57 A / A6	1000 V / 76 A / A7
rated voltage / rated current / AWG / tightening torque value UL	600 V / 15 A / 26-14 AWG	600 V / 20 A / 24-12 AWG	600 V / 30 A / 24-10 AWG	600 V / 41 A / 24-8 AWG	-	-
rated impulse withstand voltage / pollution degree	8 KV / 3	8 KV / 3	8 KV / 3	8 KV / 3	12 KV / 3	12 KV / 3
insulation stripping length (mm)	10	10	12	13	13	13
height / width / thickness 	43 / 45 / 4,2	41 / 50 / 5,2	45 / 58 / 6,2	44 / 62 / 8,2	53 / 71 / 10	56 / 80 / 12
height / width / thickness 	51 / 45 / 4,2	49 / 50 / 5,2	52 / 58 / 6,2	52 / 62 / 8,2	61 / 71 / 10	64 / 80 / 12
Marking tag printed or blank	ESP-SHZ/1	ES-NU0851	ES-NU08/61	ES-NU0851	ES-NU0851	ES-NU0851

Technical data

Technical data for ESP-HMM.x/1+2 series			
		ESP-HMM.2/1+2	ESP-HMM.4/1+2
TECHNICAL CHARACTERISTICS			
function / type		feed-through, 1 input and 2 outputs	feed-through, 1 input and 2 outputs
rated cross-section	(mm ²)	2,5	4
connecting capacity:			
flexible	(mm ²)	0.2–4	0.2–6
rigid	(mm ²)	0.2–4	0.2–6
max. flexible with ferrule	(mm ²)	2,5	4
rated voltage / rated current / gauge conf. to IEC 60947-7-1		800 V / 24 A / A3	800 V / 32 A / A4
rated voltage / rated current / AWG / tightening torque value UL		600 V / 20 A / 24-12 AWG	-
rated impulse withstand voltage / pollution degree		8 KV / 3	8 KV / 3
insulation stripping length	(mm)	10	12
height / width / thickness	TH/35 7,5 mm	76 / 69 / 8	77 / 69 / 8
height / width / thickness	TH/35 15 mm	84 / 69 / 8	85 / 69 / 8
ACCESSORIES			
End section		ESP-HMT.2/1+2/PT	ESP-HMT.4/1+2/PT
Rated current carrying capacity of jumper	(A)	24	32
Marking tag	printed or blank	ES-NU0851	ES-NU0851
End bracket		ES-BTO, ES-BT/3	ES-BTO, ES-BT/3

ESP-HMM.x/1+2 series feed through terminal blocks, 1 input and 2 outputs, grey color

- UL94V-0
- mounting onto PR/3 type rails according to IEC 60715
- standard, TH/35 type
- available in the standard version (grey)
- maximum operating temperature 100 °C
- certificate of operating temperature: -40 – +80 °C
- CoC IECEx INE 16.0032U

Cross connections Easy Bridge System

- screwless, snap-in insertion
- transversal and staggered mode connection possibility
- once inserted, intrinsically IPXXB protected resulting installation, without the need for further insulating covers
- patented system

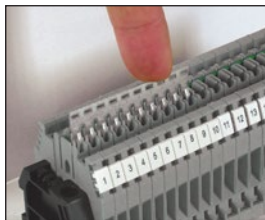

1

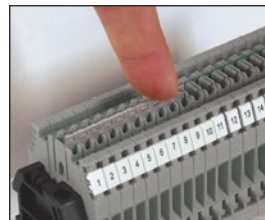

2



3

- 1-2 After having cut the bar according to the number of poles, insert the cross-connection, in the appropriate groove of the terminal block. At this point, by using the blade of a screwdriver, push down the cross-connection until it reaches its blocking point. The cross connection will be fully insulated and intrinsically IPXXB protected.
- 3 To remove the cross-connection, insert the blade of the screwdriver in the jumper slot, then lift it up and finally extract it.

Terminal block	2-pole jumper	3-pole jumper	10-pole jumper
ESP-HMM.1(**)	ESP-PTC/1/02	ESP-PTC/1/03	ESP-PTC/1/10
ESP2-HMD.1	ESP-PTC/1/02	ESP-PTC/1/03	ESP-PTC/1/10
ESP-HMM.6	ESP-PTC/8/02		ESP-PTC/8/10
ESP-HMM.10	ESP-PTC/11/02		ESP-PTC/11/10
ESP-HMM.16	ESP-PTC/16/02		ESP-PTC/16/10

Insulated cross connection

Nr. Poles	PTP Series - Blue	PTP Series - Red
2	ESP-PTP/3/02/B	ESP-PTP/3/02/R
3	ESP-PTP/3/03/B	ESP-PTP/3/03/R
10	ESP-PTP/3/10/B	ESP-PTP/3/10/R
2	ESP-PTP/5/02/B	ESP-PTP/5/02/R
3	ESP-PTP/5/03/B	ESP-PTP/5/03/R
10	ESP-PTP/5/10/B	ESP-PTP/5/10/R

ESP-PT end sections

For each type and cross section of terminal block, there is a specific insulating and closing end section to be placed on the open element of each terminal board. This end section may also be used to separate different phases of adjoining terminal blocks linked by cross connections or to increase insulation distances where specific circumstances may require it. The end sections have the same overall dimension as the related terminal block, thicknesses are given in the table below.

Terminal block	End section	
	Type	Thickness [mm]
ESP3-HLD.2	ESP3-HLD.2/PT	1,5
ESP-HMM.1	ESP-HMT.1/PT	1,5
ESP-HMM.2	ESP-HMT.2/PT	1,5
ESP-HMM.4	ESP-HMT.4/PT	1,5
ESP2-HMD.1	ESP2-HMD.1/PT	1,5
ESP2-HMD.2N	ESP2-HMD.1/PT	1,5
ESP-HMM.6	ESP-HMT.6/PT	1,5
ESP-HTE.1	ESP-HMT.1/PT	1,5
ESP-HTE.2	ESP-HMT.2/PT	1,5
ESP-HTE.4	ESP-HMT.4/PT	1,5
ESP-HTE.6	ESP-HMT.6/PT	1,5
ESP-HTE.10	ESP-HMT.10/PT	1,5
ESP-HTE.16	ESP-HMT.16/PT	1,5
ESP-HMM.1B	ESP-HMT.1/PT B	1,5
ESP-HMM.2B	ESP-HMT.2/PT B	1,5
ESP-HMM.4 B	ESP-HMT.4/PT B	1,5
ESP-HMM.6 B	ESP-HMT.6/PT B	1,5
ESP-HMM.10	ESP-HMT.10/PT	1,5
ESP-HMM.16	ESP-HMT.16/PT	1,5
ESP-HMM.10B	ESP-HMT.10/PTB	1,5
ESP-HMM.16B	ESP-HMT.16/PTB	1,5

ESP-DFH partitions

In polyamide available in red, colour, 1.5 mm thick, for the separation of elements on the terminal board, in order to make certain circuits easy to locate or to increase the insulation distances between terminal blocks. The partitions can also be used to increase the insulation distances between adjacent parallel multiple commoning bars. White and green partitions available while stocks last.

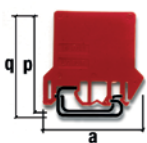

NOTE:
q dimension can be obtained by adding 4 mm to dimension p

Partition	Dimensions a x p
ESP-DFH/4	97 x 51,5
ESP-DFH/1	64 x 42,5

ESP-DFM partition insulation of cross connections - bridges

Red coloured in polyamide when it is necessary to guarantee the insulation distance between permanent or switchable cross connections, inserted between adjacent pairs of terminal blocks and, similarly, between multiple commoning bars, inserted between adjacent groups of terminal blocks.

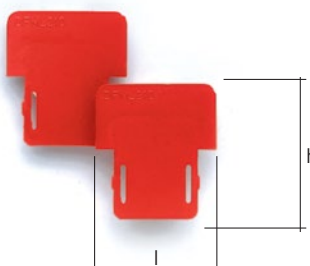

Partition	Dimensions l x h [mm]	Thickness [mm]
ESP-DFM/500	4,6 x 13,5	0,5



Technical data

Features

Earth terminal blocks ESP-HTE Series

- with UL94V-0 polyamide insulating body
- mounting onto rails according to IEC 60715 Std., "TH/35" type
- for earth connection with yellow and green insulating body

Technical data for ESP-HTE Series



	ESP-HTE.1	ESP-HTE.2	ESP-HTE.4	ESP-HTE.6	ESP-HTE.10	ESP-HTE.16
TECHNICAL CHARACTERISTICS						
function / type	earth	earth	earth	earth	earth	earth
rated cross-section (mm ²)	1,5	2,5	4	6	10	16
connecting capacity:						
flexible(mm ²)	0,2 ÷ 2,5	0,2 ÷ 4	0,2 ÷ 6	0,2 ÷ 10	1,5 ÷ 16	1,5 ÷ 25
rigid(mm ²)	0,2 ÷ 2,5	0,2 ÷ 4	0,2 ÷ 6	0,2 ÷ 10	1,5 ÷ 16	1,5 ÷ 25
max. flexible with ferrule (mm ²)-ferrule type	1,5 - WP15/14	2,5 - WP25/14	4 - WP40/16	6 - WP60/20	10 - WP100/21	16 - WP160/22
rated voltage / rated current / gauge conf. to IEC 60947-7-1	- / - / B2	- / - / A3	- / - / A4	- / - / A5	- / - / A6	- / - / A7
rated voltage / rated current / AWG UL	- / - / 26-14 AWG	- / - / 24-12 AWG	- / - / 24-10 AWG	- / - / 24-8 AWG	-	-
rated impulse withstand voltage / pollution degree	8 KV / 3	8 KV / 3	8 KV / 3	8 KV / 3	12 KV / 3	12 KV / 3
insulation stripping length (mm)	10	10	12	13	13	13
height / width / thickness 	43 / 50 / 4,2	41 / 54 / 5,2	45 / 58 / 6,2	44 / 62 / 8,2	53 / 71 / 10	56 / 80 / 12
height / width / thickness 	51 / 50 / 4,2	49 / 54 / 5,2	52 / 58 / 6,2	52 / 62 / 8,2	61 / 70 / 10	64 / 80 / 12
Marking tag printed or blank	ESP-SHZ/1, ESP-SH004S	ES-NU0851	ES-NU08/61	ES-NU0851	ES-NU0851	ES-NU0851

Features

Two level terminal blocks ESP2-HMD

- with UL94V-0 polyamide insulating body
- mounting onto rails according to IEC 60715 Std., "TH/35" type
- double possibility of PTC – "Easy Bridge" multi-pole cross connection, on each level
- available in standard grey RAL 7042 colour

Technical data for ESP-HMD

	ESP2-HMD.1	ESP2-HMD.2N
TECHNICAL CHARACTERISTICS		
function / type	two-level feed-through	two-level feed-through
rated cross-section (mm ²)	1,5	2,5
connecting capacity:		
flexible(mm ²)	0,2 ÷ 2,5	0,2 ÷ 2,5
rigid(mm ²)	0,2 ÷ 2,5	0,2 ÷ 2,5
max. flexible with ferrule (mm ²)-ferrule type	1,5 - WP15/14	1,5 - WP15/14
rated voltage / rated current / gauge conf. to IEC 60947-7-1	500 V / 17,5 A / B2	630 V / 24 A / B2
rated voltage / rated current / AWG UL	600 V / 15 A / 26-14 AWG	600 V / 15 A / 26-14 AWG
rated impulse withstand voltage / pollution degree	6 KV / 3	8 KV / 3
insulation stripping length (mm)	10	10
height / width / thickness 	59 / 73 / 4,2	59 / 73 / 5,2
height / width / thickness 	67 / 73 / 4,2	67 / 73 / 5,2
Marking tag printed or blank	ESP-SHZ/1, ESP-SH004S	ES-NU0851

Features

Three level terminal blocks ESP3-HLD

- Mounting onto rails, according to IEC 60715 Std.
- Three feed-through levels
- Available in grey (RAL 7042) colour
- “Easy bridge” jumpering system: double insertion possibility of PTC multi-pole cross-connections, without the need of an insulating protection
- Coupling possibility with each others

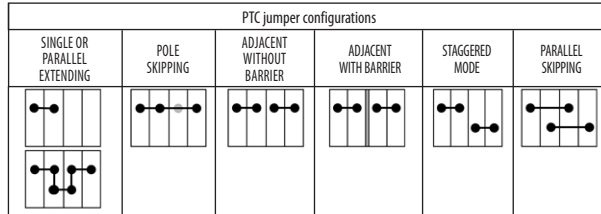

Insulation voltage in the above configurations (V)					
upper level	500	500		500	500
intermediate level	500	500		500	
lower level	500	500		500	

Technical data for ESP-HLD

		ESP3-HLD.2
TECHNICAL CHARACTERISTICS		
function / type		Three feed-through levels
rated cross-section	(mm ²)	2,5
connecting capacity:		
flexible(mm ²)		0,2 ÷ 2,5
rigid(mm ²)		0,2 ÷ 2,5
max. flexible with ferrule (mm ²)-ferrule type		1,5 - WP15/14
rated voltage / rated current / gauge conf. to IEC 60947-7-1		500 V / 24 A / B2
rated voltage / rated current / AWG UL		-
rated impulse withstand voltage / pollution degree		8 KV / 3
insulation stripping length	(mm)	10
height / width / thickness	TH/35 7,5 mm	75 / 95 / 5,2
height / width / thickness	TH/35 15 mm	83 / 95 / 5,2
Marking tag	printed or blank	ES-NU0851

ESP-HMM.x/1+2 series feed through terminal blocks, 1 input and 2 outputs, grey color

- UL94V-0
- mounting onto PR/3 type rails according to IEC 60715
- standard, TH/35 type
- available in the standard version (grey)
- maximum operating temperature 100 °C
- certificate of operating temperature: -40 – +80 °C
- CoC IECEx INE 16.0032U

Technical data for ESP-HMM.x/1+2 series			
		ESP-HMM.2/1+2	ESP-HMM.4/1+2
TECHNICAL CHARACTERISTICS			
function / type		feed-through, 1 input and 2 outputs	feed-through, 1 input and 2 outputs
rated cross-section	(mm ²)	2,5	4
connecting capacity:			
flexible	(mm ²)	0,2–4	0,2–6
rigid	(mm ²)	0,2–4	0,2–6
max. flexible with ferrule	(mm ²)	2,5	4
rated voltage / rated current / gauge conf. to IEC 60947-7-1		800 V / 24 A / A3	800 V / 32 A / A4
rated voltage / rated current / AWG / tightening torque value UL		600 V / 20 A / 24-12 AWG	-
rated impulse withstand voltage / pollution degree		8 KV / 3	8 KV / 3
insulation stripping length	(mm)	10	12
height / width / thickness	TH/35 7,5 mm	76 / 69 / 8	77 / 69 / 8
height / width / thickness	TH/35 15 mm	84 / 69 / 8	85 / 69 / 8
ACCESSORIES			
End section		ESP-HMT.2/1+2/PT	ESP-HMT.4/1+2/PT
Rated current carrying capacity of jumper	(A)	24	32
Marking tag	printed or blank	ES-NU0851	ES-NU0851
End bracket		ES-BTO, ES-BT/3	ES-BTO, ES-BT/3

Features
Disconnect terminal blocks ESP-HMS

- with UL94V-0 polyamide insulating body
- disconnect by lever and by slide link
- for test and measurement circuits
- mounting onto rails according to IEC 60715 Std., "TH/35" type
- available in standard grey RAL 7042 colour

Technical data for ESP-HMS		
		ESP-HMS.2
TECHNICAL CHARACTERISTICS		
function / type		disconnect by lever
rated cross-section	(mm ²)	2,5
connecting capacity:		
flexible(mm ²)		0,2 ÷ 4
rigid(mm ²)		0,2 ÷ 4
max. flexible with ferrule (mm ²)-ferrule type		2,5 - WP25/14
rated voltage / rated current / gauge conf. to IEC 60947-7-1		400 V / 16 A / A3
rated voltage / rated current / AWG UL		600 V / 24 A / 24-12 AWG
rated impulse withstand voltage / pollution degree		6 KV / 3
insulation stripping length	(mm)	10
height / width / thickness	TH/35 7,5 mm	37 / 66 / 5,2
height / width / thickness	TH/35 15 mm	45 / 66 / 5,2
ACCESSORIES		
End sections	grey	ESP-HMT.2/1+2/PT
Permanent cross connection (intrinsically IPXXB protected once mounted)		ESP-PTC/03/02 poles
		ESP-PTC/03/03 poles
		ESP-PTC/03/10 poles
Rated current carrying capacity of jumper	(A)	24
Marking tag	printed or blank	ES-NU0851
End bracket		ES-BTO

Features

- Potential distribution terminal blocks ESP-HMR
 - with UL94V-0 polyamide insulating body
 - 16 mm²
 - mounting onto rails according to IEC 60715 Std., "TH/35" type
 - available in grey RAL 7042 colour
 - can be connected with ESP-HMM.2

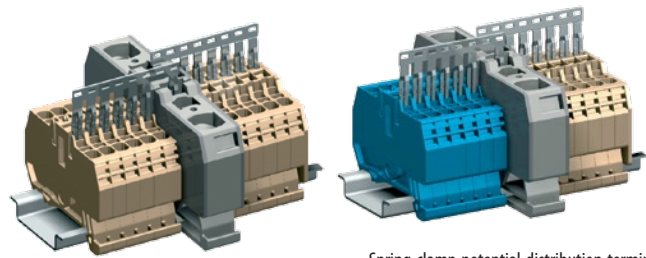

Spring clamp potential distribution terminal block, single power supply

Spring clamp potential distribution terminal block, double power supply

Technical data for ESP-HMR

		ESP-HMR.16, ESP-HMR.16/D
TECHNICAL CHARACTERISTICS		
function / type		potential distributor
rated cross-section (mm ²)		16
connecting capacity:		
flexible(mm ²)		1,5 ÷ 25
rigid(mm ²)		1,5 ÷ 25
max. flexible with ferrule (mm ²)-ferrule type		16 - WP160/22
rated voltage / rated current / gauge acc. to IEC 60947-7-1		800 V / 76 A (*) / A7
rated voltage / rated current / AWG UL		-
rated impulse withstand voltage / pollution degree		12 KV / 3
insulation stripping length (mm)		18
height / width / thickness	TH/35 7,5 mm	50 / 80 / 12,8
height / width / thickness	TH/35 15 mm	57 / 80 / 12,8
ACCESSORIES		
End sections	grey	see table
Permanent cross connection		see table
Rated current carrying capacity of jumper	(A)	see table
Coloured partition	red	ESP-DFH/4
Marking tag	printed or blank	ES-NU0851

NOTES:
 The number of poles to be used shall be equal to the number of terminal blocks to be connected, including the distribution terminal block + 1
 To allow the connection to the distribution terminal block the second pin of the PTC jumper shall be trimmed off
 *Connectable only on the open side of the distribution terminal block

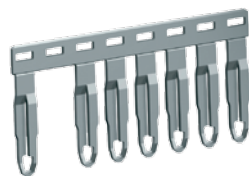

Connection

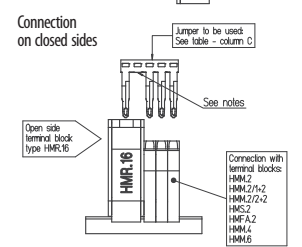
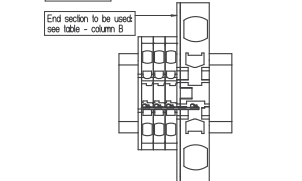
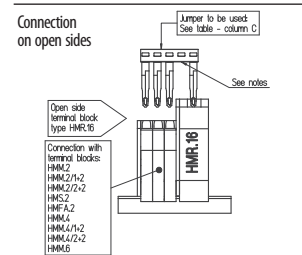
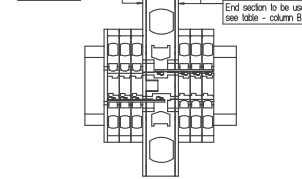
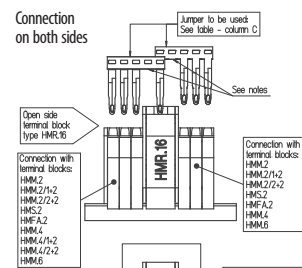

Terminal block connected to supply terminal	End sections	Permanent cross connection (**)	
		Type	Total capacity
ESP-HMM.2	ESP-HMR.16-2/PT	ESP-PTP0303 ESP-PTP0310	24 A
ESP-HMM.4	ESP-HMR.16-4/PT	ESP-PTP0503 ESP-PTP0510	32 A
ESP-HMM.6	ESP-HMR.16-6/PT	ESP-PTC/08/10 poles	41 A

(**) In order to enable the connection to the supply terminal the second pin must be always removed from the strip of the PTC jumper.

The number of poles of the PTC jumper must be equal to the number of terminal blocks to be cross-connected plus 1

Technical data

Dimensions

ES-PTM + ES-TA1640AW

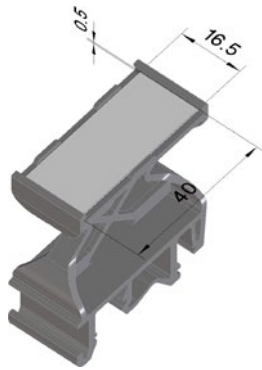

ES-PTMS + ES-TA407AW

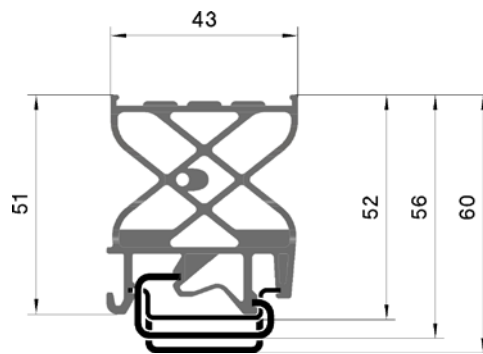
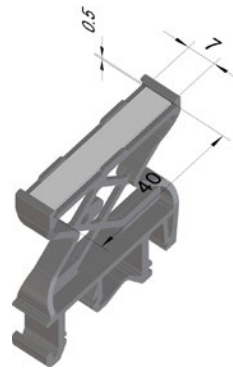

Features

- ES-PZM.4 cover suitable for terminal blocks with overall dimension up to approximately 58 mm (mounting rail included).
- ES-PZM.6 cover suitable for terminal blocks with overall dimension over 58 mm, (mounting rail included).

Technical data for ES-PZM Series

	ES-PZM.4	ES-PZM.6	ES-PZM.4 + ES-PZD.4/SO	ES-PZM.6 + ES-PZD.6/SO
TECHNICAL CHARACTERISTICS				
Dimensions (mm)	a = 64+2 / b = 32	a = 85+2 / b = 36		
Mounted with support	ES-PZD.4/SO	ES-PZD.6/SO		
Maximum dimension: (mm)				
on IEC 60715/G32 mounting rail			70 / 82 (*)	82 / 94 (*)
on IEC 60715/TH35 mounting rail			65 / 77 (*)	78 / 90 (*)

(*) depending on the notches used, upper or lower.

